

Ordering Code: 33XX-X-XX-XX
 Example: 3203-P-1/4BB-.5

Series	O-ring	Material	Connection	Crack Pressure
3300	03 - Viton 13 - Buna 24 - Silicone 32 - Ethylene Propylene	K - Kynar N - Nylon P - Polypropylene	1/8BB - 1/8" Barb x 1/8" Barb 3/16BB - 3/16" Barb x 3/16" Barb 1/4BB - 1/4" Barb x 1/4" Barb	.15 - 5 psi

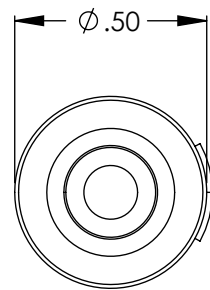

3300 Series - 1/4BB

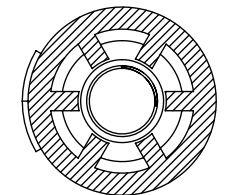
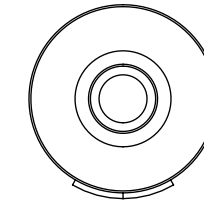
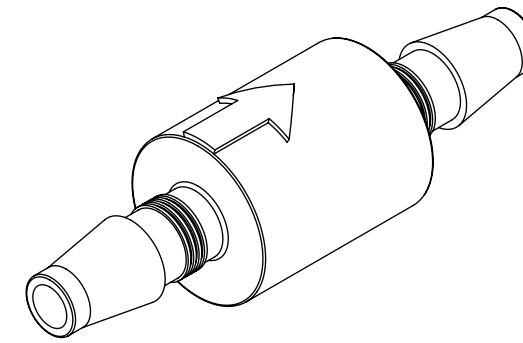
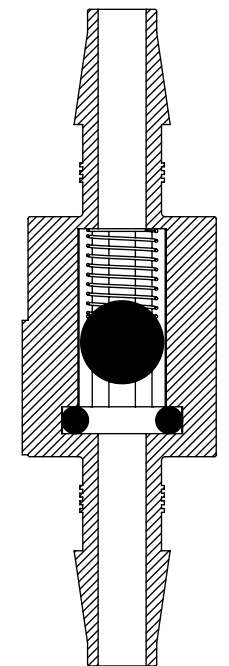
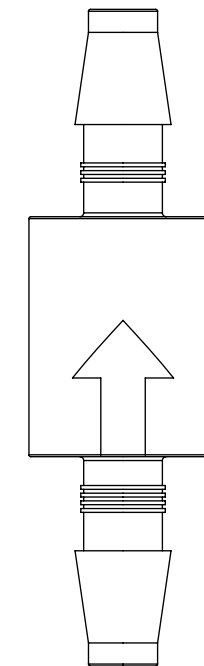
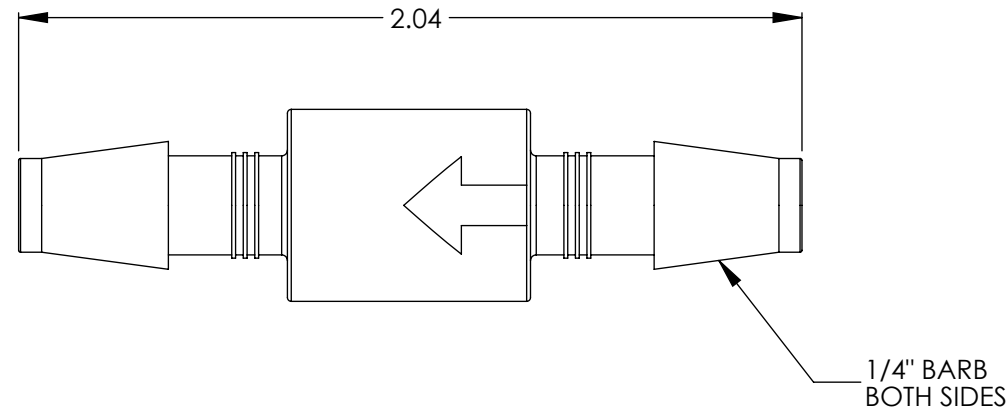

↑
Flow

Body Material: Kynar, Nylon, Polypropylene
O-ring Material: Buna-N, Ethylene Propylene, Viton, Silicone
Spring Material: 302 SST
Operating Pressure: Vacuum to 125 psig (8.61 bar)
Cracking Pressure: .15 to 5 psig (.010 bar to .34 bar) - Any crack pressure above or below standard crack pressure range consult factory
Cracking Pressure Tolerance: < 2 psig (.14 bar): +/- 10% , 2 to 5 psig (.14 - .34 bar): +/- 5%
Temperature Range: Maximum Operating Temperature +140°F (60°C)
Connection Sizes: 1/8" Barb, 3/16" Barb, 1/4" Barb

Note: 1. Proper filtration is recommended to prevent damage to the o-ring or sealing surface

VALVE CHECK		
3300 Series Plastic Check Valve - 1/4BB		
SIZE B	Sales Drawing	REV A