

Ordering Code: 2XX-X-XX-XXX

Example: D203-2-4M-75 / Including optional Dust Cover

Example: 203-2-4M-75 / Without Dust Cover

Series	O-ring	Material	Connection	Crack Pressure
200	03 - Viton 07 - Neoprene 13 - Buna 20 - Teflon 24 - Silicone 26 - Fluorosilicone 32 - Ethylene Propylene 35 - Kalrez	1C - Aluminum 2 - Brass 5 - 303 SST 5C - 316 SST 5L - 17-4 SST 4B - 12L154	1M - 1/8" Male NPT x Vent 2M - 1/4" Male NPT x Vent 3M - 3/8" Male NPT x Vent 4M - 1/2" Male NPT x Vent 6M - 3/4" Male NPT x Vent 8M - 1" Male NPT x Vent 1P - 1/8" Female NPT x Vent 2P - 1/4" Female NPT x Vent 4ST - 7/16 - 20 Male SAE x Vent 12ST - 1-1/16 - 12 Male SAE x Vent 16ST - 1-5/16 - 12 Male SAE x Vent	.5-150 psi

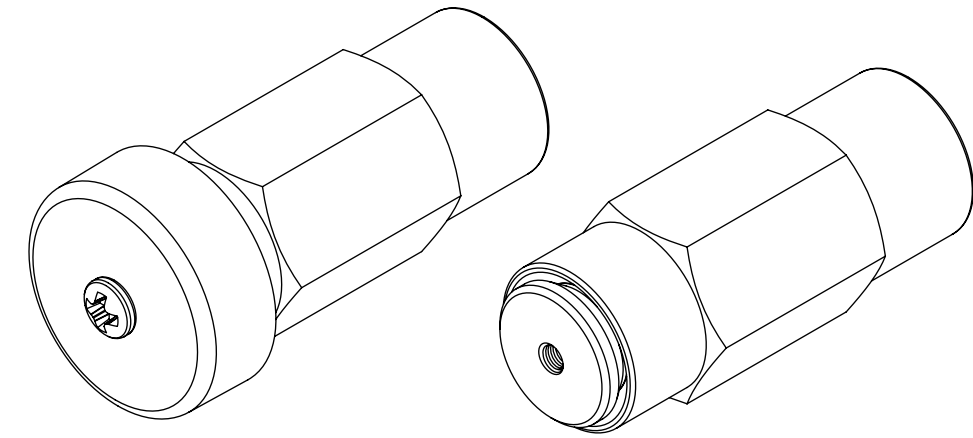

Optional Dust Cover

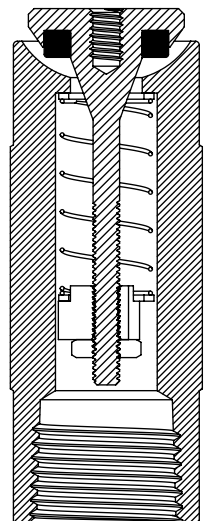
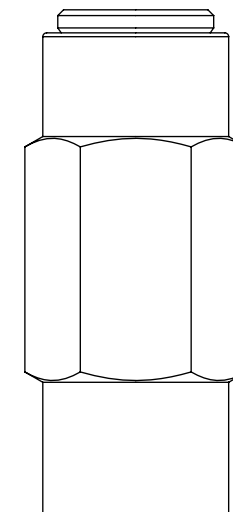
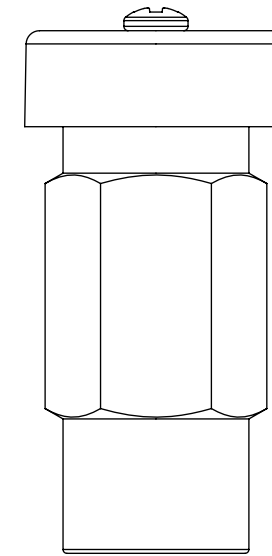
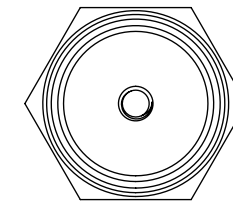
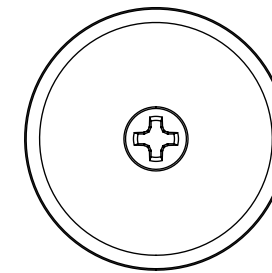
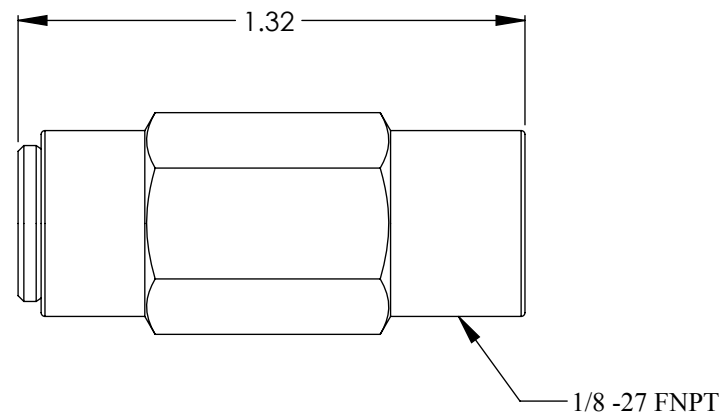
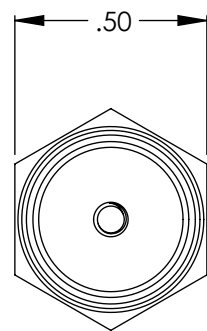

↑
Flow

Body Material: Aluminum*, Brass*, 303 SST*, 316 SST*, 17-4 SST, 12L14

O-ring Material: Buna-N**, Ethylene Propylene**, Viton**, Neoprene, Silicone, Aflas, Teflon, Florosilicone, Kalrez

Spring Material: 302 SST - Any other spring materials consult factory

Operating Pressure: Vacuum to 200 psig (14 bar)

Cracking Pressure: .5 to 150 psig (.034 bar to 10.3 bar) - Any crack pressure above or below standard crack pressure range consult factory

Cracking Pressure Tolerance: < 2 psig (.14 bar): +/- 10% , 2 to 150 psig (.14 - 10.3 bar): +/- 5%

Temperature Range: -70 °F to +400 °F (-56 °C to +204 °C) - Based on o-ring and body material

Connection Sizes: (1/8" MNPT to 1" MNPT)***, (1/8" FNPT and 1/4" FNPT)***, (4, 12, 16 SAE)***

* Standard body materials; Consult factory for availability of other body material

** Standard o-ring materials; Consult factory for availability of other o-ring material

***Standard connections sizes; Consult factory for availability of other connection sizes

Note: 1. Proper filtration is recommended to prevent damage to the o-ring or sealing surface
2. Valve may be assembled with o-rings lubricated with Krytox grease

VALVE CHECK		
200 Series Relief Valve -1P		
SIZE B	Sales Drawing	REV A