

Ordering Code: 23XX-X-XXX-XXXX

Example: 2320-2-2MP-500

Series	O-ring	Material	Connection	Crack Pressure
2300	03 - Viton 07 - Neoprene 13 - Buna 20 - Teflon 32 - Ethylene Propylene	2 - Brass 5C - 316 SST	1MP - 1/8" Male NPT x 1/8" Female NPT 2MP - 1/4" Male NPT x 1/4" Female NPT 3MP - 3/8" Male NPT x 3/8" Female NPT 4MP - 1/2" Male NPT x 1/2" Female NPT 6MP - 3/4" Male NPT x 3/4" Female NPT 8MP - 1" Male NPT x 1" Female NPT	10-2400 psi

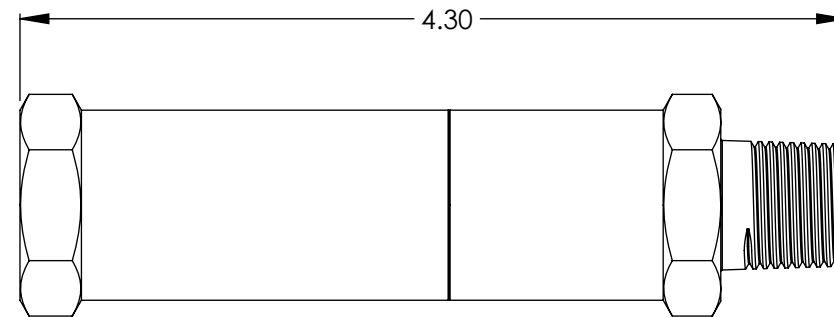
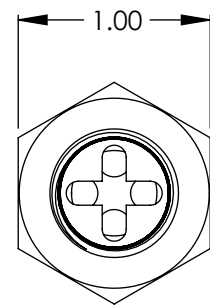
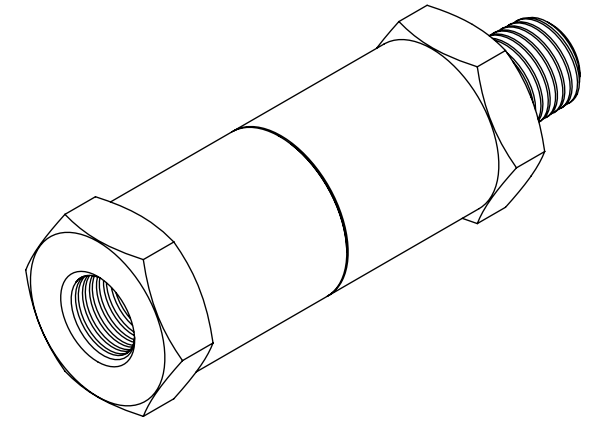

Length for crack pressures
between 451 psi to 2400 psi

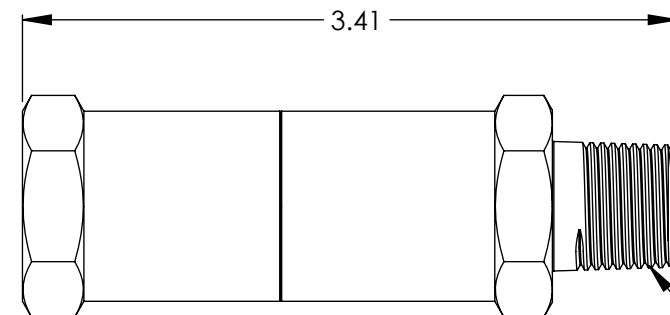
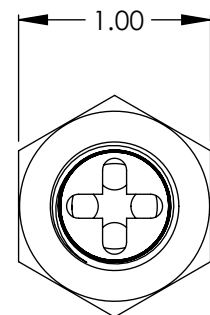
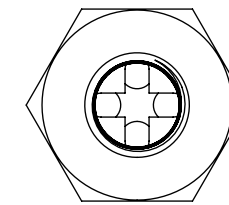

Length for crack pressures
between 10 psi to 450 psi

3/8-18 NPT INLET
& OUTLET

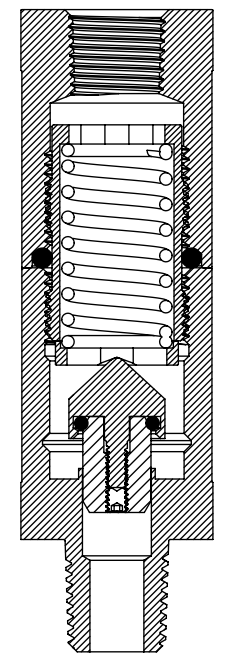

↑
Flow

2300 Series - 3MP

Body Material: Brass*, 316 SST*

O-ring Material: Buna-N**, Ethylene Propylene**, Viton**, Neoprene**, Teflon**

Spring Material: 302 SST - Any other spring materials consult factory

Operating Pressure: 0 to 2400 psig (166 bar)

Cracking Pressure: 10 to 2400 psig (.69 bar to 166 bar) - Any crack pressure above or below standard crack pressure range consult factory

Cracking Pressure Tolerance: +/- 10%

Temperature Range: -70°F to +400°F (-56°C to +204°C) - Based on o-ring and body material

Connection Sizes: (1/8" MNPT x 1/8" FNPT to 1" MNPT x 1" FNPT)***

* Standard body materials; Consult factory for availability of other body material

** Standard o-ring materials; Consult factory for availability of other o-ring material

***Standard connections sizes; Consult factory for availability of other connection sizes

Note: 1. Proper filtration is recommended to prevent damage to the o-ring or sealing surface

2. Valve may be assembled with o-rings lubricated with Krytox grease

3. Valve may contain a small amount of hydraulic oil from assembly and testing of valve, further cleaning should be done on site

VALVE CHECK		
2300 Series In-line Relief Valve - 3MP		
SIZE B	Sales Drawing	REV A