

Ordering Code: 2XX-X-XX-XXX

Example: D203-2-4M-75 / Including optional Dust Cover

Example: 203-2-4M-75 / Without Dust Cover

Series	O-ring	Material	Connection	Crack Pressure
200	03 - Viton 07 - Neoprene 13 - Buna 20 - Teflon 24 - Silicone 26 - Fluorosilicone 32 - Ethylene Propylene 35 - Kalrez	1C - Aluminum 2 - Brass 5 - 303 SST 5C - 316 SST 5L - 17-4 SST 4B - 12L154	1M - 1/8" Male NPT x Vent 2M - 1/4" Male NPT x Vent 3M - 3/8" Male NPT x Vent 4M - 1/2" Male NPT x Vent 6M - 3/4" Male NPT x Vent 8M - 1" Male NPT x Vent 1P - 1/8" Female NPT x Vent 2P - 1/4" Female NPT x Vent 4ST - 7/16 - 20 Male SAE x Vent 12ST - 1-1/16 - 12 Male SAE x Vent 16ST - 1-5/16 - 12 Male SAE x Vent	.5-150 psi

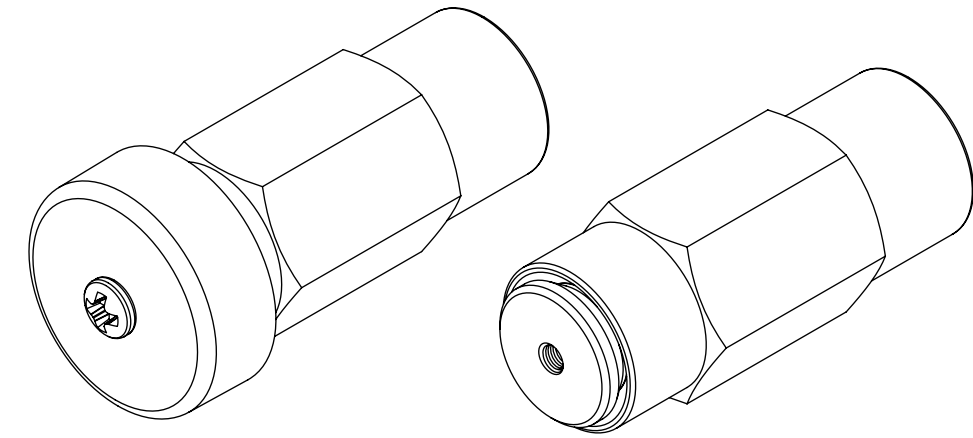

Optional Dust Cover

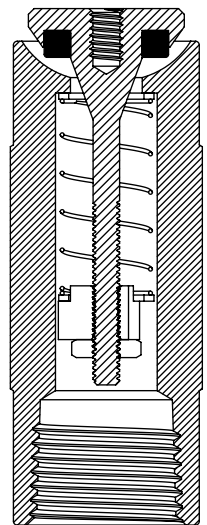
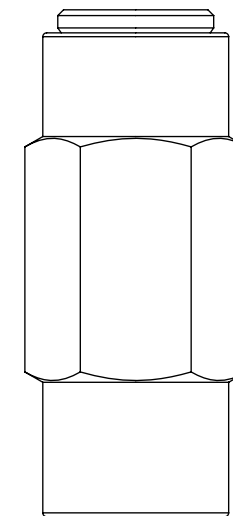
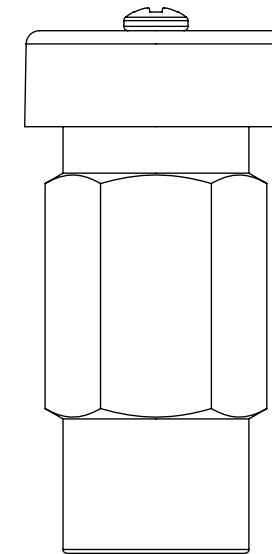
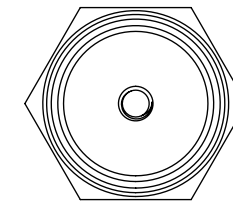
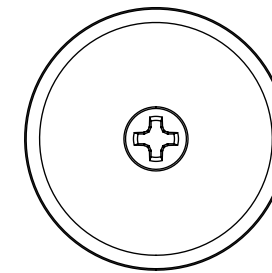
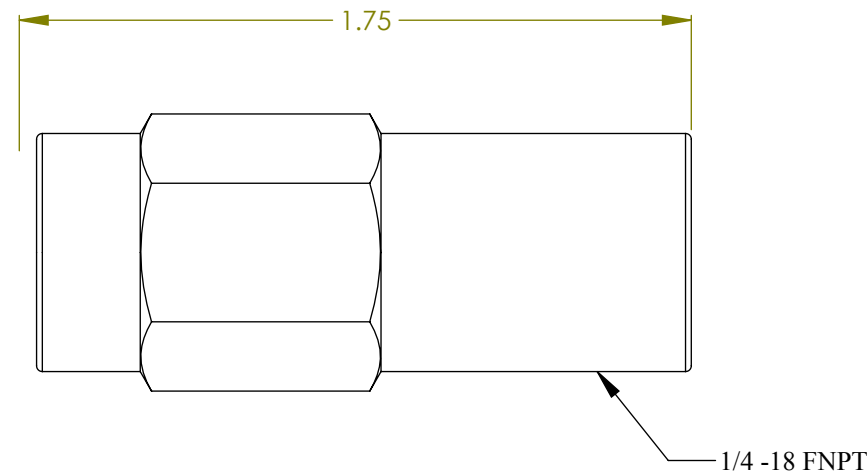
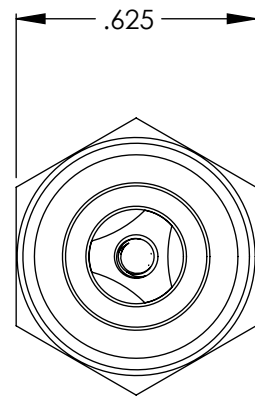

↑  
Flow

**Body Material:** Aluminum\*, Brass\*, 303 SST\*, 316 SST\*, 17-4 SST, 12L14

**O-ring Material:** Buna-N\*\*, Ethylene Propylene\*\*, Viton\*\*, Neoprene, Silicone, Aflas, Teflon, Florosilicone, Kalrez

**Spring Material:** 302 SST - Any other spring materials consult factory

**Operating Pressure:** Vacuum to 200 psig (14 bar)

**Cracking Pressure:** .5 to 150 psig (.034 bar to 10.3 bar) - Any crack pressure above or below standard crack pressure range consult factory

**Cracking Pressure Tolerance:** < 2 psig (.14 bar): +/- 10% , 2 to 150 psig (.14 - 10.3 bar): +/- 5%

**Temperature Range:** -70 °F to +400 °F (-56 °C to +204 °C) - Based on o-ring and body material

**Connection Sizes:** (1/8" MNPT to 1" MNPT)\*\*\*, (1/8" FNPT and 1/4" FNPT)\*\*\*, (4, 12, 16 SAE)\*\*\*

\* Standard body materials; Consult factory for availability of other body material

\*\* Standard o-ring materials; Consult factory for availability of other o-ring material

\*\*\*Standard connections sizes; Consult factory for availability of other connection sizes

Note: 1. Proper filtration is recommended to prevent damage to the o-ring or sealing surface  
2. Valve may be assembled with o-rings lubricated with Krytox grease

<b>VALVE CHECK</b>		
<b>200 Series Relief Valve -2P</b>		
SIZE <b>B</b>	Sales Drawing	REV <b>A</b>