

Ordering Code: 6XX-X-XXX-XX
 Example: 603-2-4PP-5

Series	O-ring	Material	Connection	Crack Pressure
600	03 - Viton 07 - Neoprene 13 - Buna 20 - Teflon 24 - Silicone 26 - Fluorosilicone 32 - Ethylene Propylene 35 - Kalrez	1C - Aluminum 2 - Brass 5 - 303 SST 5C - 316 SST 4B - 12L154	1PP - 1/8" Female NPT x 1/8" Female NPT 2PP - 1/4" Female NPT x 1/4" Female NPT 3PP - 3/8" Female NPT x 3/8" Female NPT 4PP - 1/2" Female NPT x 1/2" Female NPT 6PP - 3/4" Female NPT x 3/4" Female NPT 8PP - 1" Female NPT x 1" Female NPT 12PP - 1-1/2" Female NPT x 1-1/2" Female NPT 16PP - 2" Female NPT x 2" Female NPT	.5-5 psi

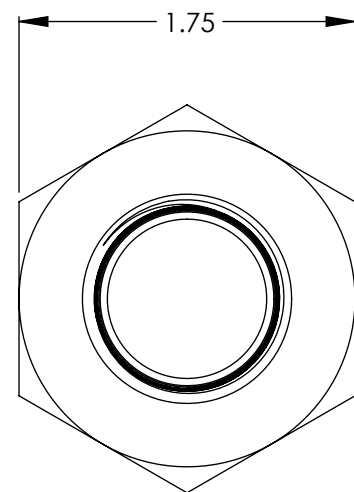

600 Series - 6PP

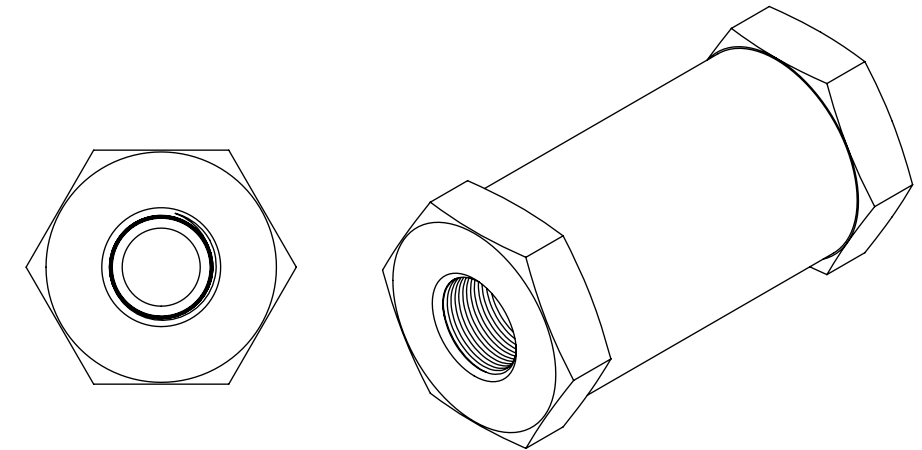
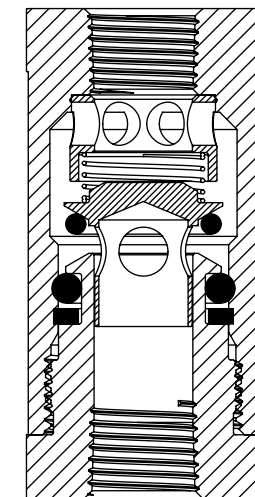
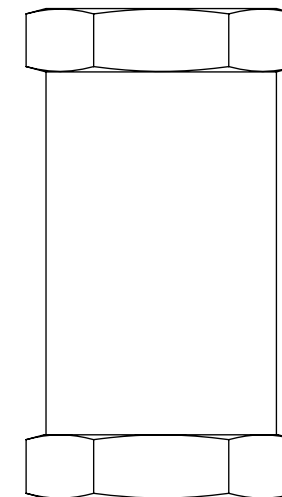
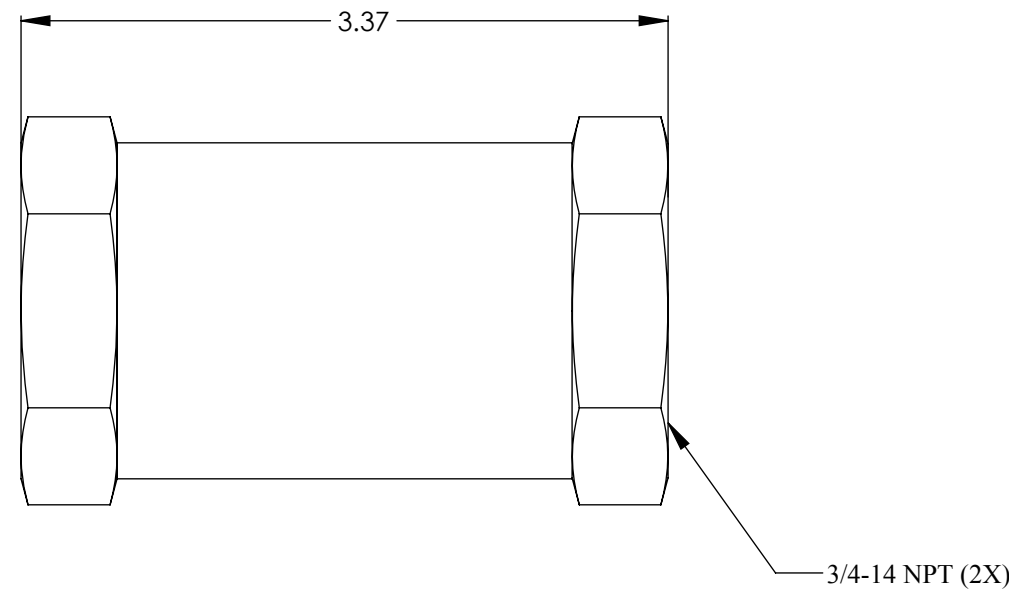

Body Material: Aluminum*, Brass*, 303 SST, 316 SST*, 12L14
O-ring Material: Buna-N**, Ethylene Propylene**, Viton**, Neoprene, Silicone, Aflas, Teflon, Florosilicone, Kalrez
Spring Material: 302 SST - Any other spring materials consult factory
Operating Pressure: Vacuum to 3000 psig (206.8 bar) / 2" NPT Brass Maximum 1500 psig (103.4 bar)
Cracking Pressure: .5 to 5 psig (.034 bar to .34 bar) - Any crack pressure above or below standard crack pressure range consult factory
Cracking Pressure Tolerance: < 2 psig (.14 bar): +/- 10% , 2 to 5 psig (.14 - .34 bar): +/- 5%
Temperature Range: -70°F to +400°F (-56°C to +204°C) - Based on o-ring and body material
Connection Sizes: (1/8" FNPT to 2" FNPT)***

* Standard body materials; Consult factory for availability of other body material
 ** Standard o-ring materials; Consult factory for availability of other o-ring material
 *** Standard connections sizes; Consult factory for availability of other connection sizes

Note: 1. Proper filtration is recommended to prevent damage to the o-ring or sealing surface
 2. Valve may be assembled with o-rings lubricated with Krytox grease

VALVE CHECK		
600 Series Inline Check Valve - 6PP		
SIZE B	Sales Drawing	REV A